









# Yuan Jewelry (H.K) CO., Limited

## tungsten ring pricelist

Phone: 86-755-33557687 Email: [info@yuan-jewelry.com](mailto:info@yuan-jewelry.com)

Website: [www.yuan-jewelry.com](http://www.yuan-jewelry.com)

item	Product Description	Picture	Unit Price
YJR001	Material: Tungsten		US\$2.80
	Color: polished shiny		
	Plating: No plating		
	Magnets: No		
	Size: All sizes including 1/2 sizes		
	Thickness: 2.3~2.5 mm		
	Width: 5 mm		
	Stone: No stone used		
	Mini Quantity: 10pcs each size and each style		
	Packing: OPP bag		
YJR002	Material: Tungsten		US\$2.90
	Color: polished shiny		
	Plating: No plating		
	Magnets: No		
	Size: All sizes including 1/2 sizes		
	Thickness: 2.3~2.5 mm		
	Width: 6 mm		
	Stone: No stone used		
	Mini Quantity: 10pcs each size and each style		
	Packing: OPP bag		
YJR003	Material: Tungsten		US\$3.20
	Color: polished shiny		
	Plating: No plating		
	Magnets: No		
	Size: All sizes including 1/2 sizes		
	Thickness: 2.3~2.5 mm		
	Width: 8 mm		
	Stone: No stone used		
	Mini Quantity: 10pcs each size and each style		
	Packing: OPP bag		
YJR004	Material: Tungsten		US\$3.50





	Color: polished shiny		
	Plating: No plating		
	Magnets: No		
	Size: All sizes including 1/2 sizes		
	Thickness: 2.3~2.5 mm		
	Width: 7 mm		
	Stone: No stone used		
	Mini Quantity: 10pcs each size and each style		
	Packing: OPP bag		
YJR005	Material: Tungsten		US\$3.30
	Color: polished shiny		
	Plating: No plating		
	Magnets: No		
	Size: All sizes including 1/2 sizes		
	Thickness: 2.3~2.5 mm		
	Width: 8 mm		
	Stone: No stone used		
	Mini Quantity: 10pcs each size and each style		
	Packing: OPP bag		
YJR006	Material: Tungsten		US\$3.20
	Color: polished shiny		
	Plating: No plating		
	Magnets: No		
	Size: :All sizes including 1/2 sizes		
	Thickness: 2.3~2.5 mm		
	Width: 6mm		
	Stone: No stone used		
	Mini Quantity: 10pcs each size and each style		
	Packing: OPP bag		
YJR007	Material: Tungsten		US\$3.70
	Color: polished shiny		
	Plating: No plating		
	Magnets: No		
	Size: :All sizes including 1/2 sizes		
	Thickness: 2.3~2.5 mm		
	Width: 7mm		
	Stone: No stone used		
	Mini Quantity: 10pcs each size and each style		
	Packing: OPP bag		





YJR008	Material: Tungsten		US\$3.60
	Color: polished shiny		
	Plating: No plating		
	Magnets: No		
	Size:All sizes including 1/2 sizes		
	Thickness:2.3~2.5 mm		
	Width:8 mm		
	Stone: No stone used		
	Mini Quantity: 10pcs each size and each style		
	Packing: OPP bag		

YJR009	Material: Tungsten		US\$3.70
	Color: brushed & polished shiny		
	Plating: No plating		
	Magnets: No		
	Size:All sizes including 1/2 sizes		
	Thickness:2.3~2.5 mm		
	Width:7mm		
	Stone: No stone used		
	Mini Quantity: 10pcs each size and each style		
	Packing: OPP bag		

YJR010	Material: Tungsten		US\$3.60
	Color: brushed & polished shiny		
	Plating: No plating		
	Magnets: No		
	Size:All sizes including 1/2 sizes		
	Thickness:2.3~2.5 mm		
	Width:8 mm		
	Stone: No stone used		
	Mini Quantity: 10pcs each size and each style		
	Packing: OPP bag		

YJR011	Material: Tungsten		US\$3.60
	Color: brushed & polished shiny		
	Plating: No plating		
	Magnets: No		
	Size:All sizes including 1/2 sizes		
	Thickness:2.3~2.5 mm		
	Width:7 mm		
	Stone:No stone used		
	Mini Quantity: 10pcs each size and each style		

	Packing: OPP bag		
YJR012	Material: Tungsten		US\$3.60
	Color: brushed		
	Plating: No plating		
	Magnets: No		
	Size: All sizes including 1/2 sizes		
	Thickness: 2.3~2.5 mm		
	Width: 8 mm		
	Stone: No stone used		
	Mini Quantity: 10pcs each size and each style		
	Packing: OPP bag		
YJR013	Material: Tungsten		US\$3.70
	Color: brushed & polished shiny		
	Plating: No plating		
	Magnets: No		
	Size: All sizes including 1/2 sizes		
	Thickness: 2.3~2.5 mm		
	Width: 6 mm		
	Stone: No stone used		
	Mini Quantity: 10pcs each size and each style		
	Packing: OPP bag		
YJR014	Material: Tungsten		US\$3.70
	Color: brushed & polished shiny		
	Plating: No plating		
	Magnets: No		
	Size: All sizes including 1/2 sizes		
	Thickness: 2.3~2.5 mm		
	Width: 8 mm		
	Stone: No stone used		
	Mini Quantity: 10pcs each size and each style		
	Packing: OPP bag		
YJR015	Material: Tungsten		US\$3.90
	Color: brushed & polished shiny		
	Plating: No plating		
	Magnets: No		
	Size: All sizes including 1/2 sizes		
	Thickness: 2.3~2.5 mm		
	Width: 8mm		

	Stone: No stone used		
	Mini Quantity: 10pcs each size and each style		
	Packing: OPP bag		
YJR016	Material: Tungsten		US\$3.60
	Color: brushed & polished shiny		
	Plating: No plating		
	Magnets: No		
	Size:All sizes including 1/2 sizes		
	Thickness:2.3~2.5 mm		
	Width:8 mm		
	Stone: No stone used		
	Mini Quantity: 10pcs each size and each style		
	Packing: OPP bag		
YJR017	Material: Tungsten		US\$3.90
	Color: brushed & polished shiny		
	Plating: No plating		
	Magnets: No		
	Size:All sizes including 1/2 sizes		
	Thickness:2.3~2.5 mm		
	Width:8 mm		
	Stone: No stone used		
	Mini Quantity: 10pcs each size and each style		
	Packing: OPP bag		
YJR018	Material: Tungsten		US\$3.90
	Color: brushed & polished shiny		
	Plating: No plating		
	Magnets: No		
	Size:All sizes including 1/2 sizes		
	Thickness:2.3~2.5 mm		
	Width:8 mm		
	Stone: No stone used		
	Mini Quantity: 10pcs each size and each style		
	Packing: OPP bag		
YJR019	Material: Tungsten		US\$3.90
	Color: brushed & polished shiny		
	Plating: No plating		
	Magnets: No		
	Size:All sizes including 1/2 sizes		

	Thickness:2.3~2.5 mm		
	Width:8 mm		
	Stone: No stone used		
	Mini Quantity: 10pcs each size and each style		
	Packing: OPP bag		



YJR020	Material: Tungsten		US\$3.70
	Color: brushed & polished shiny		
	Plating: No plating		
	Magnets: No		
	Size:All sizes including 1/2 sizes		
	Thickness:2.3~2.5 mm		
	Width:8 mm		
	Stone: No stone used		
	Mini Quantity: 10pcs each size and each style		
	Packing: OPP bag		

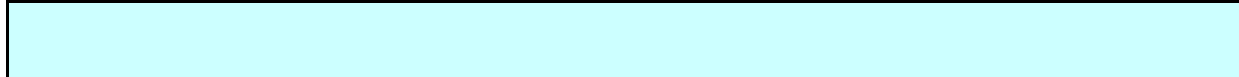

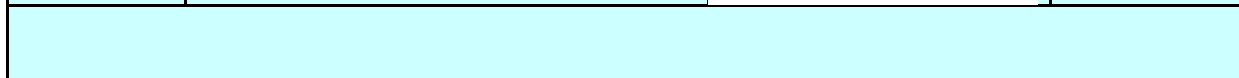

YJR021	Material: Tungsten		US\$3.90
	Color: brushed & polished shiny		
	Plating: No plating		
	Magnets: No		
	Size:All sizes including 1/2 sizes		
	Thickness:2.3~2.5 mm		
	Width:7 mm		
	Stone: No stone used		
	Mini Quantity: 10pcs each size and each style		
	Packing: OPP bag		

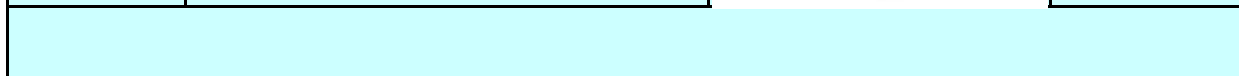

YJR022	Material: Tungsten		US\$3.70
	Color: brushed & polished shiny		
	Plating: No plating		
	Magnets: No		
	Size: :All sizes including 1/2 sizes		
	Thickness:2.3~2.5 mm		
	Width:5.5 mm		
	Stone: No stone used		
	Mini Quantity: 10pcs each size and each style		
	Packing: OPP bag		





YJR023	Material: Tungsten		US\$3.60
	Color: polished shiny		
	Plating: No plating		

	<b>Magnets: No</b>		
	<b>Size:All sizes including 1/2 sizes</b>		
	<b>Thickness:2.3~2.5 mm</b>		
	<b>Width:8 mm</b>		
	<b>Mini Quantity: 10pcs each size and each style</b>		
	<b>Packing: OPP bag</b>		

<b>YJR024</b>	<b>Material: Tungsten</b>		<b>US\$3.70</b>
	<b>Color: polished shiny &amp; Brushed</b>		
	<b>Plating: No plating</b>		
	<b>Magnets: No</b>		
	<b>Size:All sizes including 1/2 sizes</b>		
	<b>Thickness:2.3~2.5 mm</b>		
	<b>Width:6 mm</b>		
	<b>Stone: No stone used</b>		
	<b>Mini Quantity: 10pcs each size and each style</b>		
	<b>Packing: OPP bag</b>		

<b>YJR025</b>	<b>Material: Tungsten</b>		<b>US\$3.80</b>
	<b>Color: brushed &amp; polished shiny</b>		
	<b>Plating: No plating</b>		
	<b>Magnets: No</b>		
	<b>Size:All sizes including 1/2 sizes</b>		
	<b>Thickness:2.3~2.5 mm</b>		
	<b>Width:8 mm</b>		
	<b>Stone: No stone used</b>		
	<b>Mini Quantity: 10pcs each size and each style</b>		
	<b>Packing: OPP bag</b>		

<b>YJR026</b>	<b>Material: Tungsten</b>		<b>US\$3.80</b>
	<b>Color: brushed &amp; polished shiny</b>		
	<b>Plating: No plating</b>		
	<b>Magnets: No</b>		
	<b>Size:All sizes including 1/2 sizes</b>		
	<b>Thickness:2.3~2.5 mm</b>		
	<b>Width:8 mm</b>		
	<b>Mini Quantity: 10pcs each size and each style</b>		
	<b>Packing: OPP bag</b>		

<b>YJR027</b>	<b>Material: Tungsten</b>		<b>US\$3.80</b>
	<b>Color: brushed &amp; polished shiny</b>		
	<b>Plating: No plating</b>		

	<b>Magnets: No</b>		
	<b>Size:All sizes including 1/2 sizes</b>		
	<b>Thickness:2.3~2.5 mm</b>		
	<b>Width:6 mm</b>		
	<b>Stone: No stone used</b>		
	<b>Mini Quantity: 10pcs each size and each style</b>		
	<b>Packing: OPP bag</b>		

<b>YJR028</b>	<b>Material: Tungsten</b>		<b>US\$3.80</b>	
	<b>Color: brushed &amp; polished shiny</b>			
	<b>Plating: No plating</b>			
	<b>Magnets: No</b>			
	<b>Size:All sizes including 1/2 sizes</b>			
	<b>Thickness:2.3~2.5 mm</b>			
	<b>Width:8mm</b>			
	<b>Stone: No stone used</b>			
	<b>Mini Quantity: 10pcs each size and each style</b>			
	<b>Packing: OPP bag</b>			

<b>YJR029</b>	<b>Material: Tungsten</b>		<b>US\$3.70</b>	
	<b>Color: Polished shiny</b>			
	<b>Plating: No plating</b>			
	<b>Magnets: No</b>			
	<b>Size:All sizes including 1/2 sizes</b>			
	<b>Thickness:2.3~2.5 mm</b>			
	<b>Width:7mm</b>			
	<b>Stone: No stone used</b>			
	<b>Mini Quantity: 10pcs each size and each style</b>			
	<b>Packing: OPP bag</b>			

<b>YJR030</b>	<b>Material: Tungsten</b>		<b>US\$3.70</b>	
	<b>Color: polished shiny</b>			
	<b>Plating: No plating</b>			
	<b>Magnets: No</b>			
	<b>Size:All sizes including 1/2 sizes</b>			
	<b>Thickness:2.3~2.5 mm</b>			
	<b>Width:8 mm</b>			
	<b>Mini Quantity: 10pcs each size and each style</b>			
	<b>Packing: OPP bag</b>			

<b>YJR031</b>	<b>Material: Tungsten</b>		<b>US\$3.70</b>
	<b>Color:polished shiny</b>		





	Plating: No plating		
	Magnets: No		
	Size: All sizes including 1/2 sizes		
	Thickness: 2.3~2.5 mm		
	Width: 7 mm		
	Stone: No stone used		
	Mini Quantity: 10pcs each size and each style		
	Packing: OPP bag		

YJR032	Material: Tungsten		US\$3.70
	Color: polished shiny		
	Plating: No plating		
	Magnets: No		
	Size: All sizes including 1/2 sizes		
	Thickness: 2.3~2.5 mm		
	Width: 6 mm		
	Mini Quantity: 10pcs each size and each style		
	Packing: OPP bag		

YJR033	Material: Tungsten		US\$3.70
	Color: polished shiny		
	Plating: No plating		
	Magnets: No		
	Size: All sizes including 1/2 sizes		
	Thickness: 2.3~2.5 mm		
	Width: 6 mm		
	Stone: No stone used		
	Mini Quantity: 10pcs each size and each style		
	Packing: OPP bag		

YJR034	Material: Tungsten		US\$3.70
	Color: polished shiny		
	Plating: No plating		
	Magnets: No		
	Size: All sizes including 1/2 sizes		
	Thickness: 2.3~2.5 mm		
	Width: 6 mm		
	Stone: No stone used		
	Mini Quantity: 10pcs each size and each style		
	Packing: OPP bag		

YJR035	Material: Tungsten		US\$4.20
--------	--------------------	--	----------

	<b>Color: polished shiny</b>		
	<b>Plating: No plating</b>		
	<b>Magnets: No</b>		
	<b>Size:All sizes including 1/2 sizes</b>		
	<b>Thickness:2.3-2.5 mm</b>		
	<b>Width: 8 mm</b>		
	<b>Mini Quantity: 10pcs each size and each style</b>		
	<b>Packing: OPP bag</b>		

<b>YJR036</b>	<b>Material: Tungsten</b>		<b>US\$4.00</b>	
	<b>Color: polished shiny</b>			
	<b>Plating: No plating</b>			
	<b>Magnets: No</b>			
	<b>Size:All sizes including 1/2 sizes</b>			
	<b>Thickness:2.3-2.5 mm</b>			
	<b>Width: 8 mm</b>			
	<b>Mini Quantity: 10pcs each size and each style</b>			
	<b>Packing: OPP bag</b>			

<b>YJR037</b>	<b>Material: Tungsten</b>		<b>US\$4.30</b>	
	<b>Color: polished shiny</b>			
	<b>Plating: No plating</b>			
	<b>Magnets: No</b>			
	<b>Size:All sizes including 1/2 sizes</b>			
	<b>Thickness:2.3-2.5 mm</b>			
	<b>Width: 7 mm</b>			
	<b>Mini Quantity: 10pcs each size and each style</b>			
	<b>Packing: OPP bag</b>			

<b>YJR038</b>	<b>Material: Tungsten</b>		<b>US\$4.00</b>	
	<b>Color: polished shiny</b>			
	<b>Plating: No plating</b>			
	<b>Magnets: No</b>			
	<b>Size:All sizes including 1/2 sizes</b>			
	<b>Thickness:2.3-2.5 mm</b>			
	<b>Width: 7 mm</b>			
	<b>Mini Quantity: 10pcs each size and each style</b>			
	<b>Packing: OPP bag</b>			

<b>YJR039</b>	<b>Material: Tungsten</b>		<b>US\$4.00</b>	
	<b>Color: polished shiny</b>			
	<b>Plating: No plating</b>			



	<b>Magnets: No</b>		
	<b>Size: All sizes including 1/2 sizes</b>		
	<b>Thickness: 2.3-2.5 mm</b>		
	<b>Width: 7 mm</b>		
	<b>Mini Quantity: 10pcs each size and each style</b>		
	<b>Packing: OPP bag</b>		

<b>YJR040</b>	<b>Material: Tungsten</b>		<b>US\$4.30</b>
	<b>Color: polished shiny</b>		
	<b>Plating: No plating</b>		
	<b>Magnets: No</b>		
	<b>Size: All sizes including 1/2 sizes</b>		
	<b>Thickness: 2.3-2.5 mm</b>		
	<b>Width: 7 mm</b>		
	<b>Mini Quantity: 10pcs each size and each style</b>		
	<b>Packing: OPP bag</b>		

<b>YJR041</b>	<b>Material: Tungsten</b>		<b>US\$3.80</b>
	<b>Color: polished shiny</b>		
	<b>Plating: No plating</b>		
	<b>Magnets: No</b>		
	<b>Size: All sizes including 1/2 sizes</b>		
	<b>Thickness: 2.3-2.5 mm</b>		
	<b>Width: 7 mm</b>		
	<b>Mini Quantity: 10pcs each size and each style</b>		
	<b>Packing: OPP bag</b>		

<b>YJR042</b>	<b>Material: Tungsten</b>		<b>US\$3.90</b>
	<b>Color: polished shiny</b>		
	<b>Plating: No plating</b>		
	<b>Magnets: No</b>		
	<b>Size: All sizes including 1/2 sizes</b>		
	<b>Thickness: 2.3-2.5 mm</b>		
	<b>Width: 7 mm</b>		
	<b>Mini Quantity: 10pcs each size and each style</b>		
	<b>Packing: OPP bag</b>		

<b>YJR043</b>	<b>Material: Tungsten</b>		<b>US\$3.80</b>
	<b>Color: Brushed &amp; polished shiny</b>		
	<b>Plating: No plating</b>		
	<b>Magnets: No</b>		
	<b>Size: All sizes including 1/2 sizes</b>		

	Thickness:2.3~2.5 mm		
	Width: 8mm		
	Stone: No stone used		
	Mini Quantity: 10pcs each size and each style		
	Packing: OPP bag		

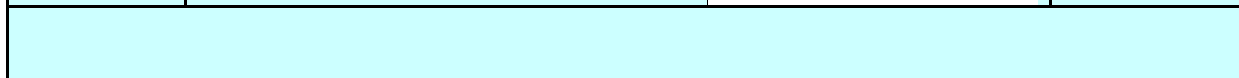

YJR044	Material: Tungsten		US\$3.80
	Color: Brushed & polished shiny		
	Plating: No plating		
	Magnets: No		
	Size: All sizes including 1/2 sizes		
	Thickness:2.3~2.5 mm		
	Width: 8mm		
	Stone: No stone used		
	Mini Quantity: 10pcs each size and each style		
	Packing: OPP bag		

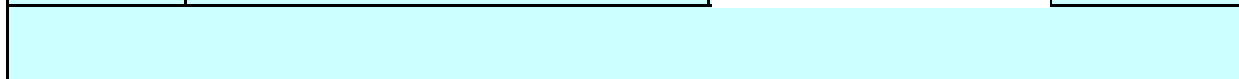

YJR045	Material: Tungsten		US\$4.10
	Color: Brushed & polished shiny		
	Plating: No plating		
	Magnets: No		
	Size: All sizes including 1/2 sizes		
	Thickness:2.3~2.5 mm		
	Width: 8mm		
	Stone: No stone used		
	Mini Quantity: 10pcs each size and each style		
	Packing: OPP bag		

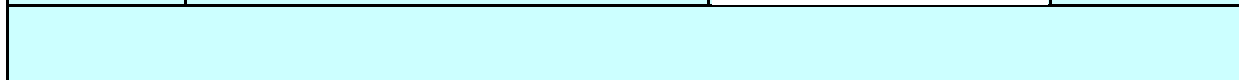

YJR046	Material: Tungsten		US\$3.70
	Color: polished shiny		
	Plating: No plating		
	Magnets: No		
	Size:All sizes including 1/2 sizes		
	Thickness:2.3~2.5 mm		
	Width:6 mm		
	Stone: No stone used		
	Mini Quantity: 10pcs each size and each style		
	Packing: OPP bag		

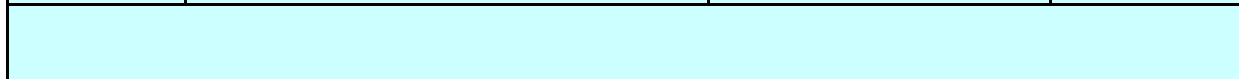

YJR047	Material: Tungsten		US\$4.00
	Color: polished shiny		
	Plating: No plating		





	Magnets: No		
	Size: All sizes including 1/2 sizes		
	Thickness: 2.3~2.5 mm		
	Width: 8 mm		
	Mini Quantity: 10pcs each size and each style		
	Packing: OPP bag		

YJR048	Material: Tungsten		US\$4.00
	Color: Brushed & polished shiny		
	Plating: No plating		
	Magnets: No		
	Size: All sizes including 1/2 sizes		
	Thickness: 2.3~2.5 mm		
	Width: 7 mm		
	Stone: No stone used		
	Mini Quantity: 10pcs each size and each style		
	Packing: OPP bag		

YJR049	Material: Tungsten		US\$3.80
	Color: Brushed & polished shiny		
	Plating: No plating		
	Magnets: No		
	Size: All sizes including 1/2 sizes		
	Thickness: 2.3~2.5 mm		
	Width: 8 mm		
	Stone: No stone used		
	Mini Quantity: 10pcs each size and each style		
	Packing: OPP bag		

YJR050	Material: Tungsten		US\$3.80
	Color: polished shiny		
	Plating: No plating		
	Magnets: No		
	Size: All sizes including 1/2 sizes		
	Thickness: 2.3~2.5 mm		
	Width: 8 mm		
	Mini Quantity: 10pcs each size and each style		
	Packing: OPP bag		

YJR051	Material: Tungsten		US\$3.80
	Color: polished shiny		
	Plating: No plating		

	<b>Magnets: No</b>		
	<b>Size:All sizes including 1/2 sizes</b>		
	<b>Thickness:2.3~2.5 mm</b>		
	<b>Width:8 mm</b>		
	<b>Mini Quantity: 10pcs each size and each style</b>		
	<b>Packing: OPP bag</b>		

<b>YJR052</b>	<b>Material: Tungsten</b>		<b>US\$3.90</b>
	<b>Color: polished shiny</b>		
	<b>Plating: No plating</b>		
	<b>Magnets: No</b>		
	<b>Size:All sizes including 1/2 sizes</b>		
	<b>Thickness:2.3~2.5 mm</b>		
	<b>Width:8 mm</b>		
	<b>Mini Quantity: 10pcs each size and each style</b>		
	<b>Packing: OPP bag</b>		

<b>YJR053</b>	<b>Material: Tungsten</b>		<b>US\$3.80</b>
	<b>Color: brushed &amp; polished shiny</b>		
	<b>Plating: No plating</b>		
	<b>Magnets: No</b>		
	<b>Size:All sizes including 1/2 sizes</b>		
	<b>Thickness:2.3~2.5 mm</b>		
	<b>Width:8 mm</b>		
	<b>Mini Quantity: 10pcs each size and each style</b>		
	<b>Packing: OPP bag</b>		

<b>YJR054</b>	<b>Material: Tungsten</b>		<b>US\$3.80</b>
	<b>Color: polished shiny</b>		
	<b>Plating: No plating</b>		
	<b>Magnets: No</b>		
	<b>Size:All sizes including 1/2 sizes</b>		
	<b>Thickness:2.3~2.5 mm</b>		
	<b>Width:8 mm</b>		
	<b>Mini Quantity: 10pcs each size and each style</b>		
	<b>Packing: OPP bag</b>		

<b>YJR055</b>	<b>Material: Tungsten</b>		<b>US\$3.80</b>
	<b>Color: polished shiny</b>		
	<b>Plating: No plating</b>		
	<b>Magnets: No</b>		
	<b>Size:All sizes including 1/2 sizes</b>		

	Thickness:2.3~2.5 mm		
	Width:8 mm		
	Mini Quantity: 10pcs each size and each style		
	Packing: OPP bag		

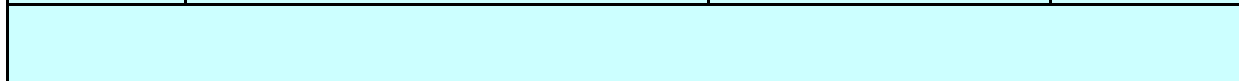

YJR056	Material: Tungsten		US\$3.90
	Color: brushed & polished shiny		
	Plating: No plating		
	Magnets: No		
	Size:All sizes including 1/2 sizes		
	Thickness:2.3~2.5 mm		
	Width:7 mm		
	Mini Quantity: 10pcs each size and each style		
	Packing: OPP bag		

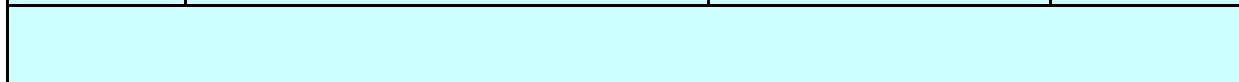



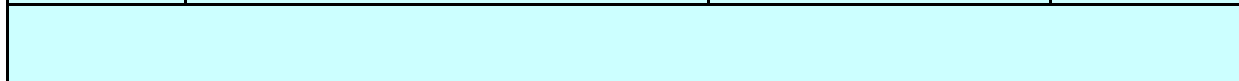

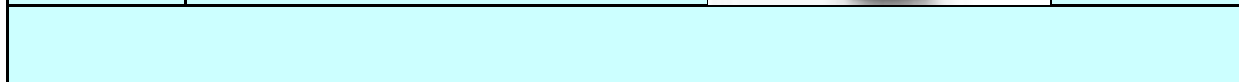

YJR057	Material: Tungsten		US\$4.30
	Color: polished shiny & Brushed		
	Plating: No plating		
	Magnets: No		
	Size:All sizes including 1/2 sizes		
	Thickness:2.3~2.5 mm		
	Width:9 mm		
	Mini Quantity: 10pcs each size and each style		
	Packing: OPP bag		







YJR058	Material: Tungsten		US\$3.80
	Color: polished shiny & Brushed		
	Plating: No plating		
	Magnets: No		
	Size:All sizes including 1/2 sizes		
	Thickness:2.3~2.5 mm		
	Width:8 mm		
	Mini Quantity: 10pcs each size and each style		
	Packing: OPP bag		









YJR059	Material: Tungsten		US\$4.20
	Color: brushed & polished shiny		
	Plating: No plating		
	Magnets: No		
	Size:All sizes including 1/2 sizes		
	Thickness:2.3~2.5 mm		
	Width:10 mm		

	Mini Quantity: 10pcs each size and each style		
	Packing: OPP bag		
YJR059-1	Material: Tungsten		US\$3.90
	Color: Brushed & polished shiny		
	Plating: No plating		
	Magnets: No		
	Size: All sizes including 1/2 sizes		
	Thickness: 2.3~2.5 mm		
	Width: 8 mm		
	Mini Quantity: 10pcs each size and each style		
	Packing: OPP bag		
YJR060	Material: Tungsten		US\$3.80
	Color: polished shiny		
	Plating: No plating		
	Magnets: No		
	Size: All sizes including 1/2 sizes		
	Thickness: 2.3~2.5 mm		
	Width: 5 mm		
	Stone: No stone used		
	Mini Quantity: 10pcs each size and each style		
	Packing: OPP bag		
YJR061	Material: Tungsten		US\$3.90
	Color: polished shiny & Brushed		
	Plating: No plating		
	Magnets: No		
	Size: All sizes including 1/2 sizes		
	Thickness: 2.3~2.5 mm		
	Width: 8 mm		
	Stone: No stone used		
	Mini Quantity: 10pcs each size and each style		
	Packing: OPP bag		
YJR062	Material: Tungsten		US\$3.80
	Color: brushed & polished shiny		
	Plating: No plating		
	Magnets: No		
	Size: All sizes including 1/2 sizes		
	Thickness: 2.3~2.5 mm		
	Width: 8 mm		



	Stone: No stone used		
	Mini Quantity: 10pcs each size and each style		
	Packing: OPP bag		
YJR063	Material: Tungsten		US\$3.80
	Color: polished shiny		
	Plating: No plating		
	Magnets: No		
	Size: All sizes including 1/2 sizes		
	Thickness: 2.3~2.5 mm		
	Width: 8 mm		
	Mini Quantity: 10pcs each size and each style		
	Packing: OPP bag		
YJR064	Material: Tungsten		US\$3.80
	Color: polished shiny		
	Plating: No plating		
	Magnets: No		
	Size: All sizes including 1/2 sizes		
	Thickness: 2.3~2.5 mm		
	Width: 7 mm		
	Mini Quantity: 10pcs each size and each style		
	Packing: OPP bag		
YJR065	Material: Tungsten		spinner ring
	Color: Brushed & polished shiny		
	Plating: No plating		
	Magnets: No		
	Size: All sizes including 1/2 sizes		
	Thickness: 2.3~2.5 mm		
	Width: 8 mm		
	Mini Quantity: 10pcs each size and each style		
	Packing: OPP bag		
YJR066	Material: Tungsten		US\$4.50
	Color: polished shiny		
	Plating: No plating		
	Magnets: No		
	Size: All sizes including 1/2 sizes		
	Thickness: 2.3~2.5 mm		
	Width: 10 mm		
	Stone: No stone used		

	Mini Quantity: 10pcs each size and each style		
	Packing: OPP bag		
YJR067	Material: Tungsten		US\$3.90
	Color: polished shiny		
	Plating: No plating		
	Magnets: No		
	Size: All sizes including 1/2 sizes		
	Thickness: 2.3~2.5 mm		
	Width: 8 mm		
	Stone: No stone used		
	Mini Quantity: 10pcs each size and each style		
	Packing: OPP bag		
YJR068	Material: Tungsten		US\$3.70
	Color: polished shiny		
	Plating: No plating		
	Magnets: No		
	Size: All sizes including 1/2 sizes		
	Thickness: 2.3~2.5 mm		
	Width: 6 mm		
	Stone: No stone used		
	Mini Quantity: 10pcs each size and each style		
	Packing: OPP bag		
YJR069	Material: Tungsten		US\$3.80
	Color: Polished shiny & Brushed		
	Plating: No plating		
	Magnets: No		
	Size: All sizes including 1/2 sizes		
	Thickness: 2.3~2.5 mm		
	Width: 8 mm		
	Stone: No stone used		
	Mini Quantity: 10pcs each size and each style		
	Packing: OPP bag		
YJR070	Material: Tungsten		US\$3.80
	Color: Polished shiny & Brushed		
	Plating: No plating		
	Magnets: No		
	Size: All sizes including 1/2 sizes		
	Thickness: 2.3~2.5 mm		

	Width:8 mm		
	Stone: No stone used		
	Mini Quantity: 10pcs each size and each style		
	Packing: OPP bag		

<b>YJR071</b>	<b>Material: Tungsten</b>		<b>US\$3.90</b>
	<b>Color: Brushed &amp; Polished shiny</b>		
	<b>Plating: No plating</b>		
	<b>Magnets: No</b>		
	<b>Size:All sizes including 1/2 sizes</b>		
	<b>Thickness:2.3~2.5 mm</b>		
	<b>Width:7 mm</b>		
	<b>Stone: No stone used</b>		
	<b>Mini Quantity: 10pcs each size and each style</b>		
	<b>Packing: OPP bag</b>		

<b>YJR072</b>	<b>Material: Tungsten</b>		<b>US\$3.80</b>
	<b>Color: Brushed &amp; Polished shiny</b>		
	<b>Plating: No plating</b>		
	<b>Magnets: No</b>		
	<b>Size:All sizes including 1/2 sizes</b>		
	<b>Thickness:2.3~2.5 mm</b>		
	<b>Width:6 mm</b>		
	<b>Stone: No stone used</b>		
	<b>Mini Quantity: 10pcs each size and each style</b>		
	<b>Packing: OPP bag</b>		

<b>YJR073</b>	<b>Material: Tungsten</b>		<b>US\$4.00</b>
	<b>Color: Brushed &amp; Polished shiny</b>		
	<b>Plating: No plating</b>		
	<b>Magnets: No</b>		
	<b>Size:All sizes including 1/2 sizes</b>		
	<b>Thickness:2.3~2.5 mm</b>		
	<b>Width:8 mm</b>		
	<b>Mini Quantity: 10pcs each size and each style</b>		
	<b>Packing: OPP bag</b>		

<b>YJR074</b>	<b>Material: Tungsten</b>		<b>US\$4.00</b>
	<b>Color: Brushed &amp; Polished shiny</b>		
	<b>Plating: No plating</b>		
	<b>Magnets: No</b>		
	<b>Size:All sizes including 1/2 sizes</b>		

	Thickness:2.3~2.5 mm		
	Width:7 mm		
	Mini Quantity: 10pcs each size and each style		
	Packing: OPP bag		

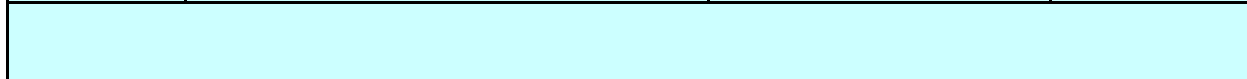

YJR075	Material: Tungsten		
	Color: polished shiny		
	Plating: No plating		
	Magnets: No		
	Size:All sizes including 1/2 sizes		
	Thickness:2.3~2.5 mm		
	Width: mm		
	Stone: No stone used		
	Mini Quantity: 10pcs each size and each style		
	Packing: OPP bag		

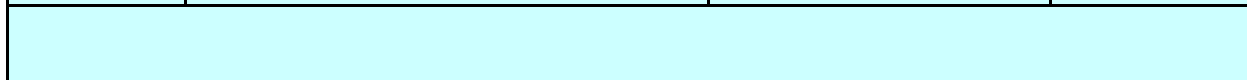

YJR076	Material: Tungsten		
	Color: polished shiny		
	Plating: No plating		
	Magnets: No		
	Size:All sizes including 1/2 sizes		
	Thickness:2.3~2.5 mm		
	Width:mm		
	Mini Quantity: 10pcs each size and each style		
	Packing: OPP bag		

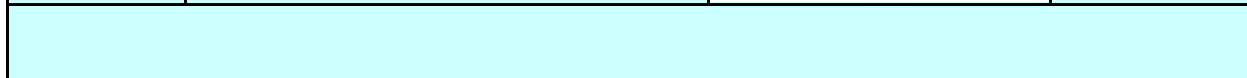



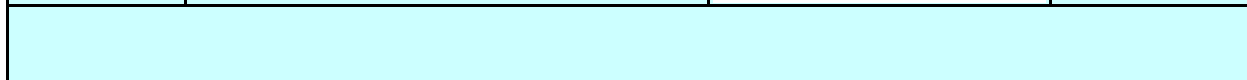



YJR077	Material: Tungsten		US\$4.50
	Color: Polished shiny & Brushed		
	Plating: No plating		
	Magnets: No		
	Size:All sizes including 1/2 sizes		
	Thickness:2.3~2.5 mm		
	Width:8 mm		
	Mini Quantity: 10pcs each size and each style		
	Packing: OPP bag		





YJR078	Material: Tungsten		US\$3.90
	Color: Brushed & Lasered		
	Plating: No plating		
	Magnets: No		
	Size:All sizes including 1/2 sizes		
	Thickness:2.3~2.5 mm		

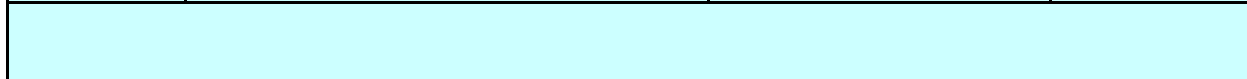

	Width:8 mm		
	Mini Quantity: 10pcs each size and each style		
	Packing: OPP bag		
YJR011	Material: Tungsten		US\$3.90
	Color: polished shiny		
	Plating: No plating		
	Magnets: No		
	Size:All sizes including 1/2 sizes		
	Thickness:2.3~2.5 mm		
	Width:7 mm		
	Mini Quantity: 10pcs each size and each style		
	Packing: OPP bag		
YJR079	Material: Tungsten		US\$4.00
	Color: polished shiny & brushed		
	Plating: No plating		
	Magnets: No		
	Size:All sizes including 1/2 sizes		
	Thickness:2.3~2.5 mm		
	Width:8 mm		
	Stone: No stone used		
	Mini Quantity: 10pcs each size and each style		
	Packing: OPP bag		
YJR080	Material: Tungsten		US\$3.90
	Color: polished shiny		
	Plating: No plating		
	Magnets: No		
	Size:All sizes including 1/2 sizes		
	Thickness:2.3~2.5 mm		
	Width:8 mm		
	Stone: No stone used		
	Mini Quantity: 10pcs each size and each style		
	Packing: OPP bag		
YJR081	Material: Tungsten		US\$3.90
	Color: polished shiny		
	Plating: No plating		
	Magnets: No		
	Size:All sizes including 1/2 sizes		
	Thickness:2.3~2.5 mm		

	Width:8 mm		
	Stone: No stone used		
	Mini Quantity: 10pcs each size and each style		
	Packing: OPP bag		



YJR082	Material: Tungsten		US\$3.80
	Color: polished shiny		
	Plating: No plating		
	Magnets: No		
	Size:All sizes including 1/2 sizes		
	Thickness:2.3~2.5 mm		
	Width:8 mm		
	Mini Quantity: 10pcs each size and each style		
	Packing: OPP bag		



YJR083	Material: Tungsten		US\$3.80
	Color: polished shiny		
	Plating: No plating		
	Magnets: No		
	Size:All sizes including 1/2 sizes		
	Thickness:2.3~2.5 mm		
	Width:7 mm		
	Mini Quantity: 10pcs each size and each style		
	Packing: OPP bag		



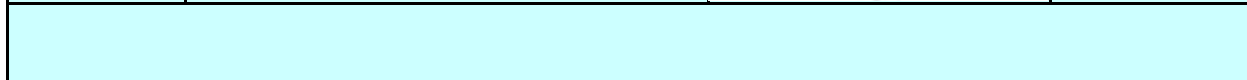

YJR084	Material: Tungsten		US\$4.50
	Color: polished shiny & brushed		
	Plating: No plating		
	Magnets: No		
	Size:All sizes including 1/2 sizes		
	Thickness:2.3~2.5 mm		
	Width:8 mm		
	Stone: No stone used		
	Mini Quantity: 10pcs each size and each style		
	Packing: OPP bag		

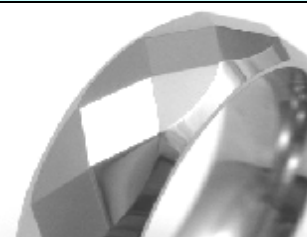



YJR085	Material: Tungsten		US\$3.90
	Color: polished shiny		
	Plating: No plating		
	Magnets: No		
	Size:All sizes including 1/2 sizes		
	Thickness:2.3~2.5 mm		





	Width:7 mm		
	Stone: No stone used		
	Mini Quantity: 10pcs each size and each style		
	Packing: OPP bag		

YJR086	Material: Tungsten		US\$3.90
	Color: polished shiny		
	Plating: No plating		
	Magnets: No		
	Size:All sizes including 1/2 sizes		
	Thickness:2.3~2.5 mm		
	Width:7 mm		
	Stone: No stone used		
	Mini Quantity: 10pcs each size and each style		
	Packing: OPP bag		

YJR087	Material: Tungsten		US\$4.10
	Color: polished shiny		
	Plating: No plating		
	Magnets: No		
	Size:All sizes including 1/2 sizes		
	Thickness:2.3~2.5 mm		
	Width:8 mm		
	Stone: No stone used		
	Mini Quantity: 10pcs each size and each style		
	Packing: OPP bag		

YJR088	Material: Tungsten		US\$3.90
	Color: polished shiny		
	Plating: No plating		
	Magnets: No		
	Size:All sizes including 1/2 sizes		
	Thickness:2.3~2.5 mm		
	Width:8 mm		
	Stone: No stone used		
	Mini Quantity: 10pcs each size and each style		
	Packing: OPP bag		

YJR089	Material: Tungsten		US\$3.90
	Color: polished shiny		
	Plating: No plating		
	Magnets: No		

	Size:All sizes including 1/2 sizes		
	Thickness:2.3~2.5 mm		
	Width:8 mm		
	Stone: No stone used		
	Mini Quantity: 10pcs each size and each style		
	Packing: OPP bag		

YJR090	Material: Tungsten		US\$3.50
	Color: polished		
	Plating: black plated		
	Magnets: No		
	Size:All sizes including 1/2 sizes		
	Thickness:2.3~2.5 mm		
	Width:6 mm		
	Mini Quantity: 10pcs each size and each style		
	Packing: OPP bag		

YJR091	Material: Tungsten		US\$3.50
	Color: polished		
	Plating: black plated		
	Magnets: No		
	Size:All sizes including 1/2 sizes		
	Thickness:2.3~2.5 mm		
	Width:5.5 mm		
	Mini Quantity: 10pcs each size and each style		
	Packing: OPP bag		

YJR092	Material: Tungsten		US\$3.50
	Color: polished		
	Plating: black plated		
	Magnets: No		
	Size:All sizes including 1/2 sizes		
	Thickness:2.3~2.5 mm		
	Width:7 mm		
	Mini Quantity: 10pcs each size and each style		
	Packing: OPP bag		

YJR093	Material: Tungsten		US\$3.55
	Color: polished		
	Plating: black plated		
	Magnets: No		
	Size:All sizes including 1/2 sizes		



	Thickness:2.3~2.5 mm		
	Width:6 mm		
	Mini Quantity: 10pcs each size and each style		
	Packing: OPP bag		

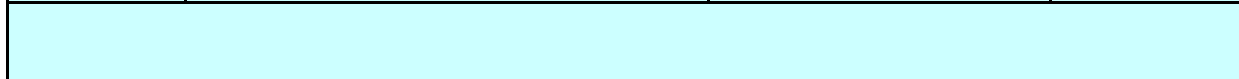

YJR094	Material: Tungsten		US\$3.60
	Color: brushed & polished shiny		
	Plating: black plated		
	Magnets: No		
	Size:All sizes including 1/2 sizes		
	Thickness:2.3~2.5 mm		
	Width:8 mm		
	Mini Quantity: 10pcs each size and each style		
	Packing: OPP bag		

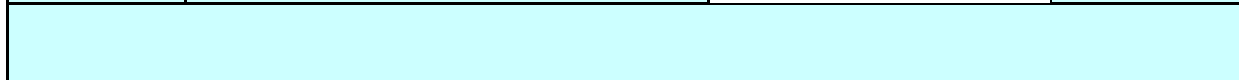

YJR095	Material: Tungsten		US\$4.00
	Color: polished and Laser		
	Plating: black plated		
	Magnets: No		
	Size:All sizes including 1/2 sizes		
	Thickness:2.3~2.5 mm		
	Width:8 mm		
	Mini Quantity: 10pcs each size and each style		
	Packing: OPP bag		



YJR096	Material: Tungsten		US\$4.00
	Color: polished and Laser		
	Plating: black plated		
	Magnets: No		
	Size:All sizes including 1/2 sizes		
	Thickness:2.3~2.5 mm		
	Width:9 mm		
	Mini Quantity: 10pcs each size and each style		
	Packing: OPP bag		

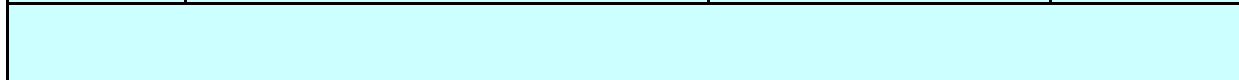

YJR097	Material: Tungsten		US\$4.00
	Color: polished and Laser		
	Plating: black plated		
	Magnets: No		
	Size:All sizes including 1/2 sizes		
	Thickness:2.3~2.5 mm		
	Width:8 mm		



	Mini Quantity: 10pcs each size and each style		
	Packing: OPP bag		
YJR098	Material: Tungsten		US\$4.00
	Color: polished and Laser		
	Plating: black plated		
	Magnets: No		
	Size: All sizes including 1/2 sizes		
	Thickness: 2.3~2.5 mm		
	Width: 8 mm		
	Mini Quantity: 10pcs each size and each style		
	Packing: OPP bag		
YJR099	Material: Tungsten		US\$3.90
	Color: polished shiny		polished center
	Plating: black plated		
	Magnets: No		
	Size: All sizes including 1/2 sizes		
	Thickness: 2.3~2.5 mm		
	Width: 8 mm		
	Mini Quantity: 10pcs each size and each style		
	Packing: OPP bag		
YJR100	Material: Tungsten		US\$3.90
	Color: polished shiny		
	Plating: black plated		
	Magnets: No		
	Size: All sizes including 1/2 sizes		
	Thickness: 2.3~2.5 mm		
	Width: 8 mm		
	Stone: No stone used		
	Mini Quantity: 10pcs each size and each style		
	Packing: OPP bag		
YJR101	Material: Tungsten		US\$3.90
	Color: polished shiny		
	Plating: black plated		
	Magnets: No		
	Size: All sizes including 1/2 sizes		
	Thickness: 2.3~2.5 mm		
	Width: 8 mm		
	Mini Quantity: 10pcs each size and each style		
	Packing: OPP bag		

	Packing: OPP bag		
YJR102	Material: Tungsten		US\$3.90
	Color: polished shiny		
	Plating: black plated		
	Magnets: No		
	Size: All sizes including 1/2 sizes		
	Thickness: 2.3~2.5 mm		
	Width: 8 mm		
	Mini Quantity: 10pcs each size and each style		
	Packing: OPP bag		
YJR103	Material: Tungsten		US\$3.90
	Color: polished shiny		
	Plating: black plated		
	Magnets: No		
	Size: All sizes including 1/2 sizes		
	Thickness: 2.3~2.5 mm		
	Width: 6 mm		
	Mini Quantity: 10pcs each size and each style		
	Packing: OPP bag		
YJR104	Material: Tungsten		US\$4.00
	Color: polished shiny and laser		
	Plating: black plated		
	Magnets: No		
	Size: All sizes including 1/2 sizes		
	Thickness: 2.3~2.5 mm		
	Width: 8 mm		
	Mini Quantity: 10pcs each size and each style		
	Packing: OPP bag		
YJR105	Material: Tungsten		US\$4.00
	Color: polished shiny and laser		
	Plating: black plated		
	Magnets: No		
	Size: All sizes including 1/2 sizes		
	Thickness: 2.3~2.5 mm		
	Width: 8 mm		
	Mini Quantity: 10pcs each size and each style		
	Packing: OPP bag		



YJR106	Material: Tungsten		US\$4.00
	Color: polished shiny and laser		
	Plating: black plated		
	Magnets: No		
	Size: All sizes including 1/2 sizes		
	Thickness: 2.3~2.5 mm		
	Width: 8 mm		
	Mini Quantity: 10pcs each size and each style		
	Packing: OPP bag		
YJR107	Material: Tungsten		US\$4.00
	Color: polished shiny and laser		
	Plating: black plated		
	Magnets: No		
	Size: All sizes including 1/2 sizes		
	Thickness: 2.3~2.5 mm		
	Width: 8 mm		
	Stone: No stone used		
	Mini Quantity: 10pcs each size and each style		
	Packing: OPP bag		
YJR108	Material: Tungsten		US\$4.00
	Color: polished shiny and laser		
	Plating: black plated		
	Magnets: No		
	Size: All sizes including 1/2 sizes		
	Thickness: 2.3~2.5 mm		
	Width: 8 mm		
	Mini Quantity: 10pcs each size and each style		
	Packing: OPP bag		
YJR109	Material: Tungsten		US\$4.00
	Color: polished shiny and laser		
	Plating: black plated		
	Magnets: No		
	Size: All sizes including 1/2 sizes		
	Thickness: 2.3~2.5 mm		
	Width: 8 mm		
	Stone: No stone used		
	Mini Quantity: 10pcs each size and each style		
	Packing: OPP bag		





YJR110	Material: Tungsten		US\$4.00
	Color: polished shiny and laser		
	Plating: black plated		
	Magnets: No		
	Size: All sizes including 1/2 sizes		
	Thickness: 2.3~2.5 mm		
	Width: 8 mm		
	Stone: No stone used		
	Mini Quantity: 10pcs each size and each style		
	Packing: OPP bag		





YJR111	Material: Tungsten		US\$4.00
	Color: polished shiny and laser		
	Plating: black plated		
	Magnets: No		
	Size: All sizes including 1/2 sizes		
	Thickness: 2.3~2.5 mm		
	Width: 8 mm		
	Stone: No stone used		
	Mini Quantity: 10pcs each size and each style		
	Packing: OPP bag		

YJR112	Material: Tungsten		US\$4.20
	Color: polished shiny and laser		
	Plating: black plated		
	Magnets: No		
	Size: All sizes including 1/2 sizes		
	Thickness: 2.3~2.5 mm		
	Width: 8 mm		
	Stone: No stone used		
	Mini Quantity: 10pcs each size and each style		
	Packing: OPP bag		

YJR113	Material: Tungsten		US\$4.20
	Color: polished shiny and laser		
	Plating: black plated		
	Magnets: No		
	Size: All sizes including 1/2 sizes		
	Thickness: 2.3~2.5 mm		
	Width: 8 mm		
	Stone: No stone used		
	Mini Quantity: 10pcs each size and each style		
	Packing: OPP bag		

	Packing: OPP bag		
YJR114	Material: Tungsten		US\$4.20
	Color: polished shiny and laser		
	Plating: black plated		
	Magnets: No		
	Size: All sizes including 1/2 sizes		
	Thickness: 2.3~2.5 mm		
	Width: 8 mm		
	Stone: No stone used		
	Mini Quantity: 10pcs each size and each style		
	Packing: OPP bag		
YJR115	Material: Tungsten		US\$4.20
	Color: polished shiny and laser		
	Plating: black plated		
	Magnets: No		
	Size: All sizes including 1/2 sizes		
	Thickness: 2.3~2.5 mm		
	Width: 8 mm		
	Stone: No stone used		
	Mini Quantity: 10pcs each size and each style		
	Packing: OPP bag		
YJR116	Material: Tungsten		US\$4.00
	Color: polished shiny and laser		
	Plating: black plated		
	Magnets: No		
	Size: All sizes including 1/2 sizes		
	Thickness: 2.3~2.5 mm		
	Width: 8 mm		
	Stone: No stone used		
	Mini Quantity: 10pcs each size and each style		
	Packing: OPP bag		
YJR117	Material: Tungsten		US\$4.00
	Color: polished shiny		
	Plating: black plated		
	Magnets: No		
	Size: All sizes including 1/2 sizes		
	Thickness: 2.3~2.5 mm		
	Width: 8 mm		

	Stone: No stone used		
	Mini Quantity: 10pcs each size and each style		
	Packing: OPP bag		
YJR118	Material: Tungsten		US\$4.00
	Color: polished shiny and laser		
	Plating: black plated		
	Magnets: No		
	Size: All sizes including 1/2 sizes		
	Thickness: 2.3~2.5 mm		
	Width: 8 mm		
	Mini Quantity: 10pcs each size and each style		
	Packing: OPP bag		
YJR119	Material: Tungsten		US\$4.30
	Color: polished shiny and laser		
	Plating: black plated		
	Magnets: No		
	Size: All sizes including 1/2 sizes		
	Thickness: 2.3~2.5 mm		
	Width: 8 mm		
	Stone: No stone used		
	Mini Quantity: 10pcs each size and each style		
	Packing: OPP bag		
YJR120	Material: Tungsten		US\$4.00
	Color: polished shiny		
	Plating: black plated		
	Magnets: No		
	Size: All sizes including 1/2 sizes		
	Thickness: 2.3~2.5 mm		
	Width: 8 mm		
	Mini Quantity: 10pcs each size and each style		
	Packing: OPP bag		
YJR121	Material: Tungsten		
	Color: polished shiny		
	Plating: black plated		
	Magnets: No		
	Size: All sizes including 1/2 sizes		
	Thickness: 2.3~2.5 mm		
	Width: 8 mm		

	Mini Quantity: 10pcs each size and each style		
	Packing: OPP bag		
YJR122	Material: Tungsten		US\$4.20
	Color: polished shiny and laser		
	Plating: black plated		
	Magnets: No		
	Size: All sizes including 1/2 sizes		
	Thickness: 2.3~2.5 mm		
	Width: 7 mm		
	Mini Quantity: 10pcs each size and each style		
	Packing: OPP bag		
YJR123	Material: Tungsten		US\$4.20
	Color: polished shiny and laser		
	Plating: black plated		
	Magnets: No		
	Size: All sizes including 1/2 sizes		
	Thickness: 2.3~2.5 mm		
	Width: 8 mm		
	Mini Quantity: 10pcs each size and each style		
	Packing: OPP bag		
YJR124	Material: Tungsten		US\$4.50
	Color: polished shiny & Brushed		
	Plating: black plated		
	Magnets: No		
	Size: All sizes including 1/2 sizes		
	Thickness: 2.3~2.5 mm		
	Width: 7 mm		
	Mini Quantity: 10pcs each size and each style		
	Packing: OPP bag		
YJR125	Material: Tungsten		US\$4.50
	Color: polished shiny & Brushed		
	Plating: black plated		
	Magnets: No		
	Size: All sizes including 1/2 sizes		
	Thickness: 2.3~2.5 mm		
	Width: 7 mm		
	Mini Quantity: 10pcs each size and each style		
	Packing: OPP bag		







YJR126	Material: Tungsten		US\$4.00
	Color: polished shiny and laser		
	Plating: black plated		
	Magnets: No		
	Size: All sizes including 1/2 sizes		
	Thickness: 2.3~2.5 mm		
	Width: 7 mm		
	Stone: No stone used		
	Mini Quantity: 10pcs each size and each style		
	Packing: OPP bag		

YJR127	Material: Tungsten		US\$4.20
	Color: polished		
	Plating: black plated		
	Magnets: No		
	Size: All sizes including 1/2 sizes		
	Thickness: 2.3~2.5 mm		
	Width: 8 mm		
	Stone: No stone used		
	Mini Quantity: 10pcs each size and each style		
	Packing: OPP bag		

YJR128	Material: Tungsten		US\$4.20
	Color: polished		
	Plating: black plated		
	Magnets: No		
	Size: All sizes including 1/2 sizes		
	Thickness: 2.3~2.5 mm		
	Width: 8 mm		
	Stone: No stone used		
	Mini Quantity: 10pcs each size and each style		
	Packing: OPP bag		

YJR129	Material: Tungsten		US\$4.00
	Color: polished shiny and laser		
	Plating: black plated		
	Magnets: No		
	Size: All sizes including 1/2 sizes		
	Thickness: 2.3~2.5 mm		
	Width: 8 mm		
	Stone: No stone used		

	Mini Quantity: 10pcs each size and each style		
	Packing: OPP bag		
YJR130	Material: Tungsten		US\$4.00
	Color: polished shiny and laser		
	Plating: black plated		
	Magnets: No		
	Size:All sizes including 1/2 sizes		
	Thickness:2.3~2.5 mm		
	Width:8 mm		
	Mini Quantity: 10pcs each size and each style		
	Packing: OPP bag		
YJR131	Material: Tungsten		US\$4.00
	Color: polished shiny and laser		
	Plating: black plated		
	Magnets: No		
	Size:All sizes including 1/2 sizes		
	Thickness:2.3~2.5 mm		
	Width:8 mm		
	Mini Quantity: 10pcs each size and each style		
	Packing: OPP bag		
YJR132	Material: Tungsten		US\$4.40
	Color: white carbon fiber & Polished		
	Plating: No plating		
	Magnets: No		
	Size:All sizes including 1/2 sizes		
	Thickness:2.3~2.5 mm		
	Width:8mm		
	Mini Quantity: 10pcs each size and each style		
	Packing: OPP bag		
YJR133	Material: Tungsten		US\$4.40
	Color: Black carbon fiber & Polished & Brushed		
	Plating: No plating		
	Magnets: No		
	Size:All sizes including 1/2 sizes		
	Thickness:2.3~2.5 mm		
	Width:8 mm		
	Mini Quantity: 10pcs each size and each style		
	Packing: OPP bag		

YJR134	Material: Tungsten		US\$4.40
	Color: black carbon fiber & polished		
	Plating: No plating		
	Magnets: No		
	Size:All sizes including 1/2 sizes		
	Thickness:2.3~2.5 mm		
	Width:8 mm		
	Mini Quantity: 10pcs each size and each style		
	Packing: OPP bag		
YJR135	Material: Tungsten		US\$4.50
	Color: wood & polished		
	Plating: No plating		
	Magnets: No		
	Size:All sizes including 1/2 sizes		
	Thickness:2.3~2.5 mm		
	Width:8 mm		
	Mini Quantity: 10pcs each size and each style		
	Packing: OPP bag		
YJR136	Material: Tungsten		US\$4.40
	Color: blue carbon fiber & polished		
	Plating: No plating		
	Magnets: No		
	Size:All sizes including 1/2 sizes		
	Thickness:2.3~2.5 mm		
	Width:8 mm		
	Mini Quantity: 10pcs each size and each style		
	Packing: OPP bag		
YJR137	Material: Tungsten		US\$5.50
	Color: blue carbon fiber & polished & brushed		
	Plating: No plating		
	Magnets: No		
	Size:All sizes including 1/2 sizes		
	Thickness:2.3~2.5 mm		
	Width:8 mm		
	Mini Quantity: 10pcs each size and each style		
	Packing: OPP bag		

YJR138	Material: Tungsten		US\$4.20
	Color: polished shiny & resin inlaid		
	Plating: No plating		
	Magnets: No		
	Size:All sizes including 1/2 sizes		
	Thickness:2.3~2.5 mm		
	Width:8 mm		
	Mini Quantity: 10pcs each size and each style		
	Packing: OPP bag		
YJR139	Material: Tungsten		US\$4.20
	Color: polished shiny & resin inlaid		
	Plating: No plating		
	Magnets: No		
	Size:All sizes including 1/2 sizes		
	Thickness:2.3~2.5 mm		
	Width:8 mm		
	Mini Quantity: 10pcs each size and each style		
	Packing: OPP bag		
YJR140	Material: Tungsten		US\$4.20
	Color: Brushed & resin inlaid		
	Plating: No plating		
	Magnets: No		
	Size:All sizes including 1/2 sizes		
	Thickness:2.3~2.5 mm		
	Width:7mm		
	Mini Quantity: 10pcs each size and each style		
	Packing: OPP bag		
YJR141	Material: Tungsten		US\$4.20
	Color: polished shiny & resin inlaid		
	Plating: No plating		
	Magnets: No		
	Size:All sizes including 1/2 sizes		
	Thickness:2.3~2.5 mm		
	Width:8 mm		
	Mini Quantity: 10pcs each size and each style		
	Packing: OPP bag		
YJR142	Material: Tungsten		US\$4.20
	Color: polished shiny & resin inlaid		

	Plating: No plating		
	Magnets: No		
	Size:All sizes including 1/2 sizes		
	Thickness:2.3~2.5 mm		
	Width:8 mm		
	Mini Quantity: 10pcs each size and each style		
	Packing: OPP bag		

YJR143	Material: Tungsten		US\$4.20
	Color: polished shiny & resin inlaid		
	Plating: No plating		
	Magnets: No		
	Size:All sizes including 1/2 sizes		
	Thickness:2.3~2.5 mm		
	Width:8 mm		
	Mini Quantity: 10pcs each size and each style		
	Packing: OPP bag		

YJR144	Material: Tungsten		US\$4.20
	Color: polished shiny & brushed & resin inlaid		
	Plating: No plating		
	Magnets: No		
	Size:All sizes including 1/2 sizes		
	Thickness:2.3~2.5 mm		
	Width:8 mm		
	Mini Quantity: 10pcs each size and each style		
	Packing: OPP bag		

YJR145	Material: Tungsten		US\$4.20
	Color: brushed & resin inlaid		
	Plating: No plating		
	Magnets: No		
	Size:All sizes including 1/2 sizes		
	Thickness:2.3~2.5 mm		
	Width:8 mm		
	Mini Quantity: 10pcs each size and each style		
	Packing: OPP bag		

YJR146	Material: Tungsten		US\$4.20
	Color: polished shiny & resin inlaid		
	Plating: No plating		
	Magnets: No		

	Size:All sizes including 1/2 sizes		
	Thickness:2.3~2.5 mm		
	Width:8 mm		
	Mini Quantity: 10pcs each size and each style		
	Packing: OPP bag		



YJR147	Material: Tungsten		US\$4.20
	Color: polished shiny & resin inlaid		
	Plating: No plating		
	Magnets: No		
	Size:All sizes including 1/2 sizes		
	Thickness:2.3~2.5 mm		
	Width:6 mm		
	Mini Quantity: 10pcs each size and each style		
	Packing: OPP bag		

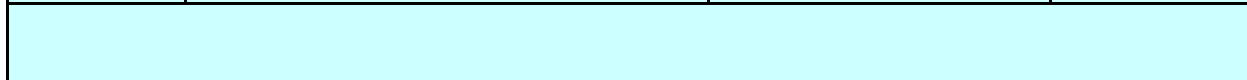



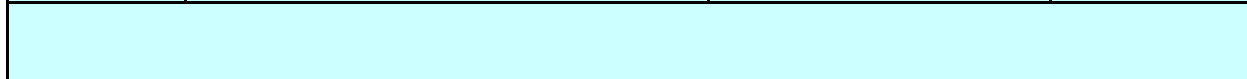

YJR148	Material: Tungsten		US\$4.20
	Color: polished shiny & resin inlaid		
	Plating: No plating		
	Magnets: No		
	Size:All sizes including 1/2 sizes		
	Thickness:2.3~2.5 mm		
	Width:8 mm		
	Mini Quantity: 10pcs each size and each style		
	Packing: OPP bag		

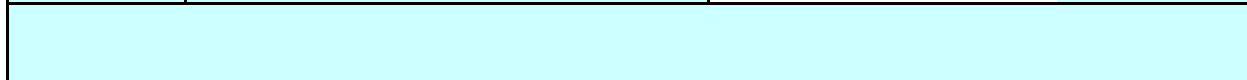

YJR149	Material: Tungsten		US\$4.20
	Color: polished shiny & resin inlaid		
	Plating: No plating		
	Magnets: No		
	Size:All sizes including 1/2 sizes		
	Thickness:2.3~2.5 mm		
	Width:8 mm		
	Mini Quantity: 10pcs each size and each style		
	Packing: OPP bag		













YJR150	Material: Tungsten		US\$4.20
	Color: polished shiny & resin inlaid		
	Plating: No plating		
	Magnets: No		
	Size:All sizes including 1/2 sizes		
	Thickness:2.3~2.5 mm		

	Width:8 mm		
	Mini Quantity: 10pcs each size and each style		
	Packing: OPP bag		
YJR151	Material: Tungsten		US\$4.20
	Color: polished shiny & resin inlaid		
	Plating: No plating		
	Magnets: No		
	Size:All sizes including 1/2 sizes		
	Thickness:2.3~2.5 mm		
	Width:8 mm		
	Mini Quantity: 10pcs each size and each style		
	Packing: OPP bag		
YJR152	Material: Tungsten		US\$4.20
	Color: polished shiny & brushed & resin inlaid		
	Plating: No plating		
	Magnets: No		
	Size:All sizes including 1/2 sizes		
	Thickness:2.3~2.5 mm		
	Width:8 mm		
	Mini Quantity: 10pcs each size and each style		
	Packing: OPP bag		
YJR153	Material: Tungsten		US\$3.80
	Color: polished shiny		
	Plating: Gold plated		
	Magnets: No		
	Size:All sizes including 1/2 sizes		
	Thickness:2.3~2.5 mm		
	Width:8 mm		
	Mini Quantity: 10pcs each size and each style		
	Packing: OPP bag		
YJR154	Material: Tungsten		US\$3.85
	Color: brushed & polished shiny		
	Plating: Gold plated		
	Magnets: No		
	Size:All sizes including 1/2 sizes		
	Thickness:2.3~2.5 mm		
	Width:7 mm		
	Stone: No stone used		





	Mini Quantity: 10pcs each size and each style		
	Packing: OPP bag		
YJR155	Material: Tungsten		US\$3.80
	Color: polished shiny		
	Plating: Gold plated		
	Magnets: No		
	Size: All sizes including 1/2 sizes		
	Thickness: 2.3~2.5 mm		
	Width: 7mm		
	Mini Quantity: 10pcs each size and each style		
	Packing: OPP bag		
YJR156	Material: Tungsten		US\$3.20
	Color: polished shiny		
	Plating: Gold plated		
	Magnets: No		
	Size: All sizes including 1/2 sizes		
	Thickness: 2.3~2.5 mm		
	Width: 5mm		
	Stone: No stone used		
	Mini Quantity: 10pcs each size and each style		
	Packing: OPP bag		
YJR157	Material: Tungsten		US\$3.40
	Color: polished shiny		
	Plating: Gold plated		
	Magnets: No		
	Size: All sizes including 1/2 sizes		
	Thickness: 2.3~2.5 mm		
	Width: 8mm		
	Stone: No stone used		
	Mini Quantity: 10pcs each size and each style		
	Packing: OPP bag		
YJR158	Material: Tungsten		US\$3.85
	Color: brushed & polished shiny		
	Plating: Gold plated		
	Magnets: No		
	Size: All sizes including 1/2 sizes		
	Thickness: 2.3~2.5 mm		
	Width: 6mm		





	Mini Quantity: 10pcs each size and each style		
	Packing: OPP bag		
YJR159	Material: Tungsten		US\$3.90
	Color: brushed & polished shiny		
	Plating: Gold plated		
	Magnets: No		
	Size: All sizes including 1/2 sizes		
	Thickness: 2.3~2.5 mm		
	Width: 8mm		
	Mini Quantity: 10pcs each size and each style		
	Packing: OPP bag		
YJR160	Material: Tungsten		US\$3.80
	Color: polished shiny		
	Plating: Gold plated		
	Magnets: No		
	Size: All sizes including 1/2 sizes		
	Thickness: 2.3~2.5 mm		
	Width: 8mm		
	Mini Quantity: 10pcs each size and each style		
	Packing: OPP bag		
YJR161	Material: Tungsten		US\$3.90
	Color: polished shiny		
	Plating: Gold plated		
	Magnets: No		
	Size: All sizes including 1/2 sizes		
	Thickness: 2.3~2.5 mm		
	Width: 7mm		
	Stone: No stone used		
	Mini Quantity: 10pcs each size and each style		
	Packing: OPP bag		
YJR162	Material: Tungsten		US\$3.80
	Color: brushed & polished shiny		
	Plating: Gold plated		
	Magnets: No		
	Size: All sizes including 1/2 sizes		
	Thickness: 2.3~2.5 mm		
	Width: 8mm		
	Mini Quantity: 10pcs each size and each style		

	Packing: OPP bag		
YJR163	Material: Tungsten		US\$3.80
	Color: polished shiny		
	Plating: Gold plated		
	Magnets: No		
	Size: All sizes including 1/2 sizes		
	Thickness: 2.3~2.5 mm		
	Width: 8mm		
	Stone: No stone used		
	Mini Quantity: 10pcs each size and each style		
	Packing: OPP bag		
YJR164	Material: Tungsten		US\$4.00
	Color: brushed & polished shiny		
	Plating: Gold plated		
	Magnets: No		
	Size: All sizes including 1/2 sizes		
	Thickness: 2.3~2.5 mm		
	Width: 8mm		
	Mini Quantity: 10pcs each size and each style		
	Packing: OPP bag		
YJR165	Material: Tungsten		US\$3.90
	Color: polished shiny		
	Plating: Gold plated		
	Magnets: No		
	Size: All sizes including 1/2 sizes		
	Thickness: 2.3~2.5 mm		
	Width: 8mm		
	Mini Quantity: 10pcs each size and each style		
	Packing: OPP bag		
YJR166	Material: Tungsten		US\$4.00
	Color: brushed & polished shiny		
	Plating: Gold plated		
	Magnets: No		
	Size: All sizes including 1/2 sizes		
	Thickness: 2.3~2.5 mm		
	Width: 8mm		
	Mini Quantity: 10pcs each size and each style		
	Packing: OPP bag		

YJR167	Material: Tungsten		US\$4.00
	Color: brushed & polished shiny		
	Plating: Gold plated		
	Magnets: No		
	Size:All sizes including 1/2 sizes		
	Thickness:2.3~2.5 mm		
	Width:8mm		
	Mini Quantity: 10pcs each size and each style		
	Packing: OPP bag		
YJR168	Material: Tungsten		US\$4.00
	Color: brushed & polished shiny & laser		
	Plating: Gold plated		
	Magnets: No		
	Size:All sizes including 1/2 sizes		
	Thickness:2.3~2.5 mm		
	Width:8mm		
	Mini Quantity: 10pcs each size and each style		
	Packing: OPP bag		
YJR169	Material: Tungsten		US\$4.00
	Color: brushed & polished shiny & laser		
	Plating: Gold plated		
	Magnets: No		
	Size:All sizes including 1/2 sizes		
	Thickness:2.3~2.5 mm		
	Width:8mm		
	Mini Quantity: 10pcs each size and each style		
	Packing: OPP bag		
YJR170	Material: Tungsten		US\$4.00
	Color: polished shiny & laser		
	Plating: Gold plated		
	Magnets: No		
	Size:All sizes including 1/2 sizes		
	Thickness:2.3~2.5 mm		
	Width:8mm		
	Mini Quantity: 10pcs each size and each style		
	Packing: OPP bag		

YJR171	Material: Tungsten		US\$4.00
	Color: polished shiny & laser		
	Plating: Gold plated		
	Magnets: No		
	Size: All sizes including 1/2 sizes		
	Thickness: 2.3~2.5 mm		
	Width: 8mm		
	Mini Quantity: 10pcs each size and each style		
	Packing: OPP bag		
YJR172	Material: Tungsten		US\$4.00
	Color: polished shiny		
	Plating: Gold plated		
	Magnets: No		
	Size: All sizes including 1/2 sizes		
	Thickness: 2.3~2.5 mm		
	Width: 8mm		
	Mini Quantity: 10pcs each size and each style		
	Packing: OPP bag		
YJR173	Material: Tungsten		US\$4.00
	Color: polished shiny & laser		
	Plating: Gold plated		
	Magnets: No		
	Size: All sizes including 1/2 sizes		
	Thickness: 2.3~2.5 mm		
	Width: 8mm		
	Stone: No stone used		
	Mini Quantity: 10pcs each size and each style		
	Packing: OPP bag		
YJR174	Material: Tungsten		
	Color: polished shiny		
	Plating: Gold plated		
	Magnets: No		
	Size: All sizes including 1/2 sizes		
	Thickness: 2.3~2.5 mm		
	Width: 8mm		
	Mini Quantity: 10pcs each size and each style		
	Packing: OPP bag		
YJR175	Material: Tungsten		US\$4.00

	Color: polished shiny & laser		
	Plating: Gold plated		
	Magnets: No		
	Size: All sizes including 1/2 sizes		
	Thickness: 2.3~2.5 mm		
	Width: 8mm		
	Mini Quantity: 10pcs each size and each style		
	Packing: OPP bag		

YJR176	Material: Tungsten		US\$3.90
	Color: polished shiny & laser		
	Plating: no		
	Magnets: No		
	Size: All sizes including 1/2 sizes		
	Thickness: 2.3~2.5 mm		
	Width: 8mm		
	Mini Quantity: 10pcs each size and each style		
	Packing: OPP bag		

YJR177	Material: Tungsten		US\$4.10
	Color: polished shiny & laser		
	Plating: Gold plated		
	Magnets: No		
	Size: All sizes including 1/2 sizes		
	Thickness: 2.3~2.5 mm		
	Width: 8mm		
	Mini Quantity: 10pcs each size and each style		
	Packing: OPP bag		

YJR178	Material: Tungsten		US\$3.95
	Color: polished shiny & laser		
	Plating: Gold plated		
	Magnets: No		
	Size: All sizes including 1/2 sizes		
	Thickness: 2.3~2.5 mm		
	Width: 6mm		
	Stone: No stone used		
	Mini Quantity: 10pcs each size and each style		
	Packing: OPP bag		

YJR179	Material: Tungsten		US\$3.95
	Color: polished shiny & laser		

	Plating: Gold plated		
	Magnets: No		
	Size:All sizes including 1/2 sizes		
	Thickness:2.3~2.5 mm		
	Width:6 mm		
	Mini Quantity: 10pcs each size and each style		
	Packing: OPP bag		

YJR180	Material: Tungsten		US\$4.00
	Color: polished shiny		
	Plating: Gold plated		
	Magnets: No		
	Size:All sizes including 1/2 sizes		
	Thickness:2.3~2.5 mm		
	Width:7 mm		
	Mini Quantity: 10pcs each size and each style		
	Packing: OPP bag		

YJR181	Material: Tungsten		US\$4.00
	Color: polished shiny		
	Plating: Gold plated		
	Magnets: No		
	Size:All sizes including 1/2 sizes		
	Thickness:2.3~2.5 mm		
	Width:7 mm		
	Mini Quantity: 10pcs each size and each style		
	Packing: OPP bag		

YJR182	Material: Tungsten		US\$4.00
	Color: polished shiny & Brushed		
	Plating: Gold plated		
	Magnets: No		
	Size:All sizes including 1/2 sizes		
	Thickness:2.3~2.5 mm		
	Width:8 mm		
	Stone: No stone used		
	Mini Quantity: 10pcs each size and each style		
	Packing: OPP bag		

YJR183	Material: Tungsten		US\$4.20
	Color: polished shiny & brushed		
	Plating: Gold plated		

	<b>Magnets: No</b>		
	<b>Size: All sizes including 1/2 sizes</b>		
	<b>Thickness: 2.3~2.5 mm</b>		
	<b>Width: 7 mm</b>		
	<b>Mini Quantity: 10pcs each size and each style</b>		
	<b>Packing: OPP bag</b>		

<b>YJR184</b>	<b>Material: Tungsten</b>		<b>US\$3.90</b>
	<b>Color: polished shiny</b>		
	<b>Plating: Gold plated</b>		
	<b>Magnets: No</b>		
	<b>Size: All sizes including 1/2 sizes</b>		
	<b>Thickness: 2.3~2.5 mm</b>		
	<b>Width: 8 mm</b>		
	<b>Mini Quantity: 10pcs each size and each style</b>		
	<b>Packing: OPP bag</b>		

<b>YJR185</b>	<b>Material: Tungsten</b>		<b>US\$4.20</b>
	<b>Color: polished shiny &amp; brushed</b>		
	<b>Plating: Gold plated</b>		
	<b>Magnets: No</b>		
	<b>Size: All sizes including 1/2 sizes</b>		
	<b>Thickness: 2.3~2.5 mm</b>		
	<b>Width: 7 mm</b>		
	<b>Mini Quantity: 10pcs each size and each style</b>		
	<b>Packing: OPP bag</b>		

<b>YJR186</b>	<b>Material: Tungsten</b>		<b>US\$4.00</b>
	<b>Color: polished shiny &amp; laser</b>		
	<b>Plating: Gold plated</b>		
	<b>Magnets: No</b>		
	<b>Size: All sizes including 1/2 sizes</b>		
	<b>Thickness: 2.3~2.5 mm</b>		
	<b>Width: 8 mm</b>		
	<b>Mini Quantity: 10pcs each size and each style</b>		
	<b>Packing: OPP bag</b>		

<b>YJR187</b>	<b>Material: Tungsten</b>		<b>US\$5.50</b>
	<b>Color: brushed &amp; polished shiny</b>		
	<b>Plating: Gold plated</b>		
	<b>Magnets: No</b>		
	<b>Size: All sizes including 1/2 sizes</b>		

	Thickness:2.3~2.5 mm		
	Width:8 mm		
	Stone: 3 stones used		
	Mini Quantity: 10pcs each size and each style		
	Packing: OPP bag		

YJR188	Material: Tungsten		US\$5.50
	Color: brushed & polished shiny		
	Plating: Rose gold plated		
	Magnets: No		
	Size:All sizes including 1/2 sizes		
	Thickness:2.3~2.5 mm		
	Width:8 mm		
	Stone: 3 stones used		
	Mini Quantity: 10pcs each size and each style		
	Packing: OPP bag		

YJR189	Material: Tungsten		US\$3.70
	Color: polished shiny & laser		
	Plating: No plating		
	Magnets: No		
	Size:All sizes including 1/2 sizes		
	Thickness:2.3~2.5 mm		
	Width:8mm		
	Mini Quantity: 10pcs each size and each style		
	Packing: OPP bag		

YJR190	Material: Tungsten		US\$3.80
	Color: brushed & polished shiny & laser		
	Plating: No plating		
	Magnets: No		
	Size:All sizes including 1/2 sizes		
	Thickness:2.3~2.5 mm		
	Width:8mm		
	Mini Quantity: 10pcs each size and each style		
	Packing: OPP bag		

YJR191	Material: Tungsten		US\$3.70
	Color: polished shiny & laser		
	Plating: No plating		
	Magnets: No		
	Size:All sizes including 1/2 sizes		



	Thickness:2.3~2.5 mm		
	Width:8mm		
	Mini Quantity: 10pcs each size and each style		
	Packing: OPP bag		

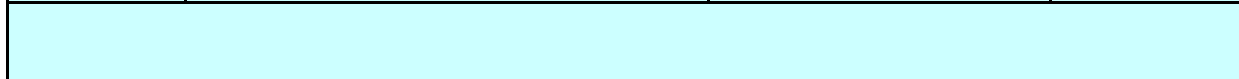

YJR192	Material: Tungsten		US\$3.90
	Color: brushed & polished shiny & laser		
	Plating: No plating		
	Magnets: No		
	Size:All sizes including 1/2 sizes		
	Thickness:2.3~2.5 mm		
	Width:8mm		
	Mini Quantity: 10pcs each size and each style		
	Packing: OPP bag		

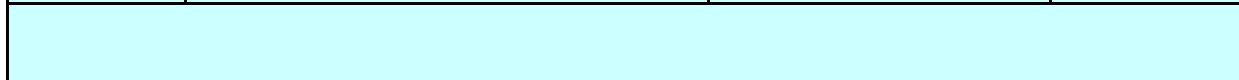

YJR193	Material: Tungsten		US\$3.90
	Color: brushed & polished shiny & laser		
	Plating: No plating		
	Magnets: No		
	Size:All sizes including 1/2 sizes		
	Thickness:2.3~2.5 mm		
	Width:8mm		
	Mini Quantity: 10pcs each size and each style		
	Packing: OPP bag		



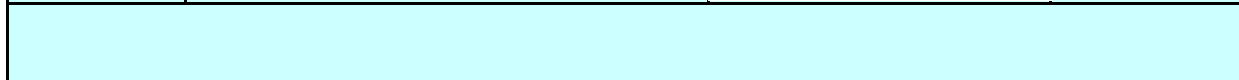

YJR194	Material: Tungsten		US\$3.90
	Color: brushed & polished shiny & laser		
	Plating: No plating		
	Magnets: No		
	Size:All sizes including 1/2 sizes		
	Thickness:2.3~2.5 mm		
	Width:8mm		
	Mini Quantity: 10pcs each size and each style		
	Packing: OPP bag		





YJR195	Material: Tungsten		US\$3.70
	Color: polished shiny & laser		
	Plating: No plating		
	Magnets: No		
	Size:All sizes including 1/2 sizes		
	Thickness:2.3~2.5 mm		
	Width:8mm		

	Mini Quantity: 10pcs each size and each style	
	Packing: OPP bag	

YJR196	Material: Tungsten		US\$3.70
	Color: polished shiny & laser		
	Plating: No plating		
	Magnets: No		
	Size: All sizes including 1/2 sizes		
	Thickness: 2.3~2.5 mm		
	Width: 8mm		
	Mini Quantity: 10pcs each size and each style		
	Packing: OPP bag		

YJR197	Material: Tungsten		US\$3.70
	Color: polished shiny & laser		
	Plating: No plating		
	Magnets: No		
	Size: All sizes including 1/2 sizes		
	Thickness: 2.3~2.5 mm		
	Width: 8mm		
	Stone: No stone used		
	Mini Quantity: 10pcs each size and each style		
	Packing: OPP bag		

YJR198	Material: Tungsten		US\$3.70
	Color: polished shiny & laser		
	Plating: No plating		
	Magnets: No		
	Size: All sizes including 1/2 sizes		
	Thickness: 2.3~2.5 mm		
	Width: 6mm		
	Stone: No stone used		
	Mini Quantity: 10pcs each size and each style		
	Packing: OPP bag		

YJR199	Material: Tungsten		US\$3.70
	Color: polished shiny & laser		
	Plating: No plating		
	Magnets: No		
	Size: All sizes including 1/2 sizes		
	Thickness: 2.3~2.5 mm		
	Width: 8mm		

	Stone: No stone used		
	Mini Quantity: 10pcs each size and each style		
	Packing: OPP bag		
YJR200	Material: Tungsten		US\$3.80
	Color: polished shiny & brushed & laser		
	Plating: No plating		
	Magnets: No		
	Size: All sizes including 1/2 sizes		
	Thickness: 2.3~2.5 mm		
	Width: 8 mm		
	Stone: No stone used		
	Mini Quantity: 10pcs each size and each style		
	Packing: OPP bag		
YJR201	Material: Tungsten		US\$3.80
	Color: polished shiny & brushed & laser		
	Plating: No plating		
	Magnets: No		
	Size: All sizes including 1/2 sizes		
	Thickness: 2.3~2.5 mm		
	Width: 7 mm		
	Mini Quantity: 10pcs each size and each style		
	Packing: OPP bag		
YJR202	Material: Tungsten		US\$3.90
	Color: polished shiny & brushed & laser		
	Plating: No plating		
	Magnets: No		
	Size: All sizes including 1/2 sizes		
	Thickness: 2.3~2.5 mm		
	Width: 8 mm		
	Stone: No stone used		
	Mini Quantity: 10pcs each size and each style		
	Packing: OPP bag		
YJR203	Material: Tungsten		US\$3.95
	Color: polished shiny & laser		
	Plating: No plating		
	Magnets: No		
	Size: All sizes including 1/2 sizes		
	Thickness: 2.3~2.5 mm		

	Width:8 mm		
	Mini Quantity: 10pcs each size and each style		
	Packing: OPP bag		
YJR204	Material: Tungsten		US\$3.95
	Color: polished shiny & laser		
	Plating: No plating		
	Magnets: No		
	Size:All sizes including 1/2 sizes		
	Thickness:2.3~2.5 mm		
	Width:7 mm		
	Stone: No stone used		
	Mini Quantity: 10pcs each size and each style		
	Packing: OPP bag		
YJR205	Material: Tungsten		US\$3.70
	Color: polished shiny & laser		
	Plating: No plating		
	Magnets: No		
	Size:All sizes including 1/2 sizes		
	Thickness:2.3~2.5 mm		
	Width:8 mm		
	Mini Quantity: 10pcs each size and each style		
	Packing: OPP bag		
YJR206	Material: Tungsten		US\$3.80
	Color: polished shiny & laser		
	Plating: No plating		
	Magnets: No		
	Size:All sizes including 1/2 sizes		
	Thickness:2.3~2.5 mm		
	Width:6 mm		
	Stone: no stone used		
	Mini Quantity: 10pcs each size and each style		
YJR207	Material: Tungsten		US\$3.80
	Color: polished shiny & brushed & laser		
	Plating: No plating		
	Magnets: No		
	Size:All sizes including 1/2 sizes		
	Thickness:2.3~2.5 mm		
	Width:6 mm		

	Stone: no stone used		
	Mini Quantity: 10pcs each size and each style		
YJR208	Material: Tungsten		US\$3.80
	Color: polished shiny & laser		
	Plating: No plating		
	Magnets: No		
	Size: All sizes including 1/2 sizes		
	Thickness: 2.3~2.5 mm		
	Width: 8 mm		
	Stone: no stone used		
	Mini Quantity: 10pcs each size and each style		
YJR209	Material: Tungsten		US\$3.80
	Color: polished shiny & laser		
	Plating: No plating		
	Magnets: No		
	Size: All sizes including 1/2 sizes		
	Thickness: 2.3~2.5 mm		
	Width: 6 mm		
	Mini Quantity: 10pcs each size and each style		
YJR210	Material: Tungsten		US\$3.80
	Color: polished shiny & laser		
	Plating: No plating		
	Magnets: No		
	Size: All sizes including 1/2 sizes		
	Thickness: 2.3~2.5 mm		
	Width: 8 mm		
	Stone: no stone used		
	Mini Quantity: 10pcs each size and each style		
YJR211	Material: Tungsten		US\$4.00
	Color: polished shiny & laser		
	Plating: gold plated		
	Magnets: No		
	Size: All sizes including 1/2 sizes		
	Thickness: 2.3~2.5 mm		
	Width: 8 mm		
	Stone: no stone used		
	Mini Quantity: 10pcs each size and each style		

YJR212	Material: Tungsten		US\$4.00
	Color: polished shiny & laser		
	Plating: black plated		
	Magnets: No		
	Size: All sizes including 1/2 sizes		
	Thickness: 2.3~2.5 mm		
	Width: 8 mm		
	Stone: no stone used		
	Mini Quantity: 10pcs each size and each style		

YJR213	Material: Tungsten		US\$4.00
	Color: polished shiny		
	Plating: No plating		
	Size: All sizes including 1/2 sizes		
	Thickness: 2.3~2.5 mm		
	Width: 6 mm		
	Stone: 1 stone used		
	Mini Quantity: 10pcs each size and each style		
	Packing: OPP bag		

YJR214	Material: Tungsten		US\$4.00
	Color: brushed & polished shiny		
	Plating: No plating		
	Size: All sizes including 1/2 sizes		
	Thickness: 2.3~2.5 mm		
	Width: 7mm		
	Stone: 1 stone used		
	Mini Quantity: 10pcs each size and each style		
	Packing: OPP bag		

YJR215	Material: Tungsten		US\$4.00
	Color: polished shiny		
	Plating: No plating		
	Size: All sizes including 1/2 sizes		
	Thickness: 2.3~2.5 mm		
	Width: 8 mm		
	Stone: 1 stone used		
	Mini Quantity: 10pcs each size and each style		
	Packing: OPP bag		

YJR216	Material: Tungsten		US\$4.00
--------	--------------------	--	----------

	Color: brushed & polished shiny	
	Plating: No plating	
	Size:All sizes including 1/2 sizes	
	Thickness:2.3~2.5 mm	
	Width:8 mm	
	Stone: 1 stone used	
	Mini Quantity: 10pcs each size and each style	
	Packing: OPP bag	



YJR217	Material: Tungsten
	Color: brushed & polished shiny
	Plating: No plating
	Size:All sizes including 1/2 sizes
	Thickness:2.3~2.5 mm
	Width:8 mm
	Stone: 1 stone used
	Mini Quantity: 10pcs each size and each style
	Packing: OPP bag



US\$4.00

YJR218	Material: Tungsten
	Color: brushed & polished shiny
	Plating: No plating
	Size:All sizes including 1/2 sizes
	Thickness:2.3~2.5 mm
	Width:7 mm
	Stone: 1 stone used
	Mini Quantity: 10pcs each size and each style
	Packing: OPP bag



US\$4.00

YJR219	Material: Tungsten
	Color: polished shiny
	Plating: No plating
	Size:All sizes including 1/2 sizes
	Thickness:2.3~2.5 mm
	Width:7 mm
	Stone: 1 stone used
	Mini Quantity: 10pcs each size and each style
	Packing: OPP bag



US\$4.10

YJR220	Material: Tungsten
	Color: polished shiny
	Plating: No plating





US\$4.10

	Size:All sizes including 1/2 sizes		
	Thickness:2.3~2.5 mm		
	Width:8 mm		
	Stone: 1 stone used		
	Mini Quantity: 10pcs each size and each style		
	Packing: OPP bag		

YJR221	Material: Tungsten		US\$4.80
	Color: brushed & polished shiny		
	Plating: No plating		
	Size:All sizes including 1/2 sizes		
	Thickness:2.3~2.5 mm		
	Width:8mm		
	Stone: 3 stones used		
	Mini Quantity: 10pcs each size and each style		
	Packing: OPP bag		

YJR222	Material: Tungsten		US\$4.80
	Color: brushed & polished shiny		
	Plating: No plating		
	Size:All sizes including 1/2 sizes		
	Thickness:2.3~2.5 mm		
	Width:8 mm		
	Stone: 3 stones used		
	Mini Quantity: 10pcs each size and each style		
	Packing: OPP bag		

YJR223	Material: Tungsten		US\$5.00
	Color: polished shiny		
	Plating: black plated		
	Size:All sizes including 1/2 sizes		
	Thickness:2.3~2.5 mm		
	Width:8mm		
	Stone: 3 stones used		
	Mini Quantity: 10pcs each size and each style		
	Packing: OPP bag		

YJR224	Material: Tungsten		US\$5.00
	Color: polished shiny		
	Plating: No plating		
	Size:All sizes including 1/2 sizes		
	Thickness:2.3~2.5 mm		





	<b>Width:8 mm</b>		
	<b>Stone: 6 stones used</b>		
	<b>Mini Quantity: 10pcs each size and each style</b>		
	<b>Packing: OPP bag</b>		

<b>YJR225</b>	<b>Material: Tungsten</b>		<b>US\$5.20</b>
	<b>Color: Polished shiny</b>		
	<b>Plating: No plating</b>		
	<b>Size: :All sizes including 1/2 sizes</b>		
	<b>Thickness:2.3~2.5 mm</b>		
	<b>Width:8 mm</b>		
	<b>Stone: 6 stones used</b>		
	<b>Mini Quantity: 10pcs each size and each style</b>		
	<b>Packing: OPP bag</b>		

<b>YJR226</b>	<b>Material: Tungsten</b>		<b>US\$5.00</b>
	<b>Color: brushed</b>		
	<b>Plating: No plating</b>		
	<b>Magnets: No</b>		
	<b>Size: :All sizes including 1/2 sizes</b>		
	<b>Thickness:2.3~2.5 mm</b>		
	<b>Width: 8 mm</b>		
	<b>Stone: 3 stones used</b>		
	<b>Mini Quantity: 10pcs each size and each style</b>		
	<b>Packing: OPP bag</b>		

<b>YJR227</b>	<b>Material: Tungsten</b>		<b>US\$5.00</b>
	<b>Color: brushed &amp; polished shiny</b>		
	<b>Plating: No plating</b>		
	<b>Magnets: No</b>		
	<b>Size: :All sizes including 1/2 sizes</b>		
	<b>Thickness:2.3~2.5 mm</b>		
	<b>Width:8 mm</b>		
	<b>Stone: 6 stones used</b>		
	<b>Mini Quantity: 10pcs each size and each style</b>		
	<b>Packing: OPP bag</b>		

<b>YJR228</b>	<b>Material: Tungsten</b>		<b>US\$4.20</b>
	<b>Color: brushed &amp; polished shiny</b>		
	<b>Plating: No plating</b>		
	<b>Magnets: No</b>		
	<b>Size: :All sizes including 1/2 sizes</b>		

	Thickness:2.3~2.5 mm		
	Width: 8 mm		
	Stone: 1 stone inlaid		
	Mini Quantity: 10pcs each size and each style		
	Packing: OPP bag		



YJR229	Material: Tungsten		US\$4.50
	Color: Polished shiny		
	Plating: black plated		
	Size: :All sizes including 1/2 sizes		
	Thickness:2.3~2.5 mm		
	Width:8 mm		
	Stone: 1 stone used		
	Mini Quantity: 10pcs each size and each style		
	Packing: OPP bag		

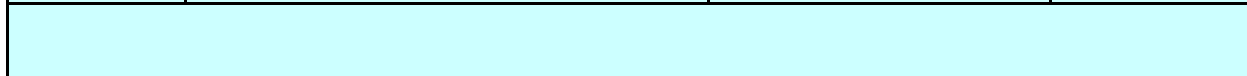

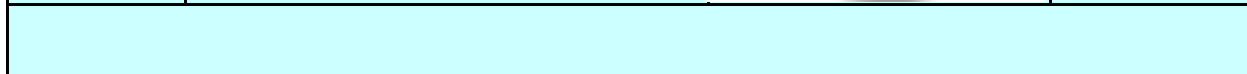

YJR230	Material: Tungsten		US\$4.10
	Color: brushed & polished shiny		
	Plating: No plating		
	Size: :All sizes including 1/2 sizes		
	Thickness:2.3~2.5 mm		
	Width:8 mm		
	Stone: 1 stone used		
	Mini Quantity: 10pcs each size and each style		
	Packing: OPP bag		

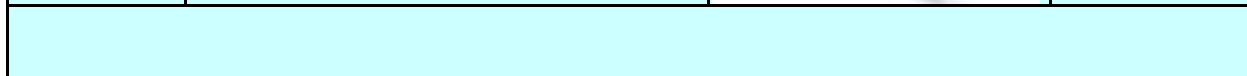

YJR231	Material: Tungsten		US\$4.50
	Color: Polished shiny		
	Plating: No plating		
	Size: :All sizes including 1/2 sizes		
	Thickness:2.3~2.5 mm		
	Width:5 mm		
	Stone:4 stones used		
	Mini Quantity: 10pcs each size and each style		
	Packing: OPP bag		



YJR232	Material: Tungsten		US\$5.00
	Color: polished shiny		
	Plating: No plating		
	Magnets: No		
	Size: :All sizes including 1/2 sizes		
	Thickness:2.3~2.5 mm		





	<b>Width:8 mm</b>		
	<b>Stone: 3 stones used</b>		
	<b>Mini Quantity: 10pcs each size and each style</b>		
	<b>Packing: OPP bag</b>		



<b>YJR233</b>	<b>Material: Tungsten</b>		<b>US\$4.10</b>
	<b>Color: polished shiny and brushed</b>		
	<b>Plating: No plating</b>		
	<b>Size:All sizes including 1/2 sizes</b>		
	<b>Thickness:2.3~2.5 mm</b>		
	<b>Width:8 mm</b>		
	<b>Stone: 1 stone used</b>		
	<b>Mini Quantity: 10pcs each size and each style</b>		
	<b>Packing: OPP bag</b>		

<b>YJR234</b>	<b>Material: Tungsten</b>		<b>US\$4.20</b>
	<b>Color: polished shiny</b>		
	<b>Plating: No plating</b>		
	<b>Magnets: No</b>		
	<b>Size:All sizes including 1/2 sizes</b>		
	<b>Thickness:2.3~2.5 mm</b>		
	<b>Width:8 mm</b>		
	<b>Stone: 1 stone used</b>		
	<b>Mini Quantity: 10pcs each size and each style</b>		
	<b>Packing: OPP bag</b>		

<b>YJR235</b>	<b>Material: Tungsten</b>		<b>US\$4.20</b>
	<b>Color: polished shiny</b>		
	<b>Plating: No plating</b>		
	<b>Size:All sizes including 1/2 sizes</b>		
	<b>Thickness:2.3~2.5 mm</b>		
	<b>Width:8 mm</b>		
	<b>Stone: 1 stone used</b>		
	<b>Mini Quantity: 10pcs each size and each style</b>		
	<b>Packing: OPP bag</b>		

<b>YJR236</b>	<b>Material: Tungsten &amp; ceramic</b>		<b>US\$9.50</b>
	<b>Color: polished shiny</b>		
	<b>Plating: No plating</b>		
	<b>Size:All sizes including 1/2 sizes</b>		
	<b>Thickness:2.3~2.5 mm</b>		
	<b>Width:8mm</b>		

	Stone: No stone used		
	Mini Quantity: 10pcs each size and each style		
	Packing: OPP bag		
YJR237	Material: Tungsten & shell		US\$5.00
	Color: polished shiny		
	Plating: No plating		
	Magnets: No		
	Size:All sizes including 1/2 sizes		
	Thickness:2.3~2.5 mm		
	Width:8 mm		
	Mini Quantity: 10pcs each size and each style		
	Packing: OPP bag		
YJR238	Material: Tungsten & shell		US\$5.00
	Color: polished shiny		
	Plating: No plating		
	Magnets: No		
	Size:All sizes including 1/2 sizes		
	Thickness:2.3~2.5 mm		
	Width:8 mm		
	Mini Quantity: 10pcs each size and each style		
	Packing: OPP bag		
YJR239	Material: Tungsten & shell		US\$5.00
	Color: polished shiny		
	Plating: No plating		
	Magnets: No		
	Size:All sizes including 1/2 sizes		
	Thickness:2.3~2.5 mm		
	Width:8 mm		
	Mini Quantity: 10pcs each size and each style		
	Packing: OPP bag		
YJR240	Material: Tungsten & shell		US\$5.00
	Color: polished shiny		
	Plating: No plating		
	Magnets: No		
	Size:All sizes including 1/2 sizes		
	Thickness:2.3~2.5 mm		
	Width:8 mm		
	Mini Quantity: 10pcs each size and each style		
	Packing: OPP bag		

	Packing: OPP bag		
YJR241	Material: Tungsten & ceramic		
	Color: polished shiny & brushed		
	Plating: No plating		
	Magnets: No		
	Size: All sizes including 1/2 sizes		
	Thickness: 2.3~2.5 mm		
	Width: 7 mm		
	Mini Quantity: 10pcs each size and each style		
	Packing: OPP bag		
YJR242	Material: Tungsten & ceramic		
	Color: polished shiny & brushed		
	Plating: No plating		
	Magnets: No		
	Size: All sizes including 1/2 sizes		
	Thickness: 2.3~2.5 mm		
	Width: 8 mm		
	Mini Quantity: 10pcs each size and each style		
	Packing: OPP bag		
YJR243	Material: Tungsten & ceramic		
	Color: polished shiny & brushed		
	Plating: No plating		
	Magnets: No		
	Size: All sizes including 1/2 sizes		
	Thickness: 2.3~2.5 mm		
	Width: 7 mm		
	Mini Quantity: 10pcs each size and each style		
	Packing: OPP bag		
YJR244	Material: Tungsten & ceramic		
	Color: polished shiny & brushed		
	Plating: No plating		
	Magnets: No		
	Size: All sizes including 1/2 sizes		
	Thickness: 2.3~2.5 mm		
	Width: 8 mm		
	Mini Quantity: 10pcs each size and each style		
	Packing: OPP bag		



	Color: brushed		
	Plating: Gold plated		
	Magnets: No		
	Size: All sizes including 1/2 sizes		
	Thickness: 2.3~2.5 mm		
	Width: 6 mm		
	Mini Quantity: 10pcs each size and each style		
	Packing: OPP bag		

YJR250	Material: Tungsten		US\$3.80
	Color: polished shiny and brushed		
	Plating: Gold plated		
	Magnets: No		
	Size: All sizes including 1/2 sizes		
	Thickness: 2.3~2.5 mm		
	Width: 6 mm		
	Mini Quantity: 10pcs each size and each style		
	Packing: OPP bag		

YJR251	Material: Tungsten		US\$3.90
	Color: polished shiny and brushed		
	Plating: Gold plated		
	Magnets: No		
	Size: All sizes including 1/2 sizes		
	Thickness: 2.3~2.5 mm		
	Width: 8 mm		
	Mini Quantity: 10pcs each size and each style		
	Packing: OPP bag		

YJR252	Material: Tungsten		US\$3.90
	Color: polished shiny		
	Plating: Gold plated		
	Magnets: No		
	Size: All sizes including 1/2 sizes		
	Thickness: 2.3~2.5 mm		
	Width: 8 mm		
	Mini Quantity: 10pcs each size and each style		
	Packing: OPP bag		

YJR253	Material: Tungsten		US\$5.00
	Color: polished shiny		shell inlaid
	Plating: no plated		

	<b>Magnets: No</b>		
	<b>Size: All sizes including 1/2 sizes</b>		
	<b>Thickness: 2.3~2.5 mm</b>		
	<b>Width: 4 mm</b>		
	<b>Mini Quantity: 10pcs each size and each style</b>		
	<b>Packing: OPP bag</b>		

<b>YJR254</b>	<b>Material: Tungsten</b>		<b>US\$4.20</b>
	<b>Color: polished shiny</b>		
	<b>Plating: Black plated</b>		
	<b>Magnets: No</b>		
	<b>Size: All sizes including 1/2 sizes</b>		
	<b>Thickness: 2.3~2.5 mm</b>		
	<b>Width: 8 mm</b>		
	<b>Mini Quantity: 10pcs each size and each style</b>		
	<b>Packing: OPP bag</b>		

<b>YJR255</b>	<b>Material: Tungsten</b>		<b>US\$3.90</b>
	<b>Color: polished shiny</b>		
	<b>Plating: Black plated</b>		
	<b>Magnets: No</b>		
	<b>Size: All sizes including 1/2 sizes</b>		
	<b>Thickness: 2.3~2.5 mm</b>		
	<b>Width: 8 mm</b>		
	<b>Mini Quantity: 10pcs each size and each style</b>		
	<b>Packing: OPP bag</b>		

<b>YJR256</b>	<b>Material: Tungsten</b>		<b>US\$5.60</b>
	<b>Color: polished shiny</b>		
	<b>Plating: Black plated</b>		
	<b>Magnets: No</b>		
	<b>Size: All sizes including 1/2 sizes</b>		
	<b>Thickness: 2.3~2.5 mm</b>		
	<b>Width: 8 mm</b>		
	<b>Mini Quantity: 10pcs each size and each style</b>		
	<b>Packing: OPP bag</b>		